

MODEL 196LRC MEDIUM DUTY BELT DRIVEN LIVE ROLLER CURVE

24 HOUR SHIPMENTS INCLUDE 45°, 90° AND 180° CURVES



Conveyor shown with optional supports

Roach model 196LRC features tapered rollers to maintain product orientation. Reversible, it is also commonly slave driven from 196VP and 196CALR conveyors.

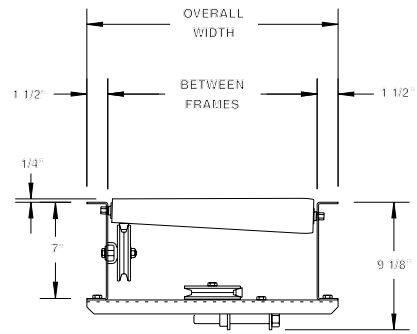
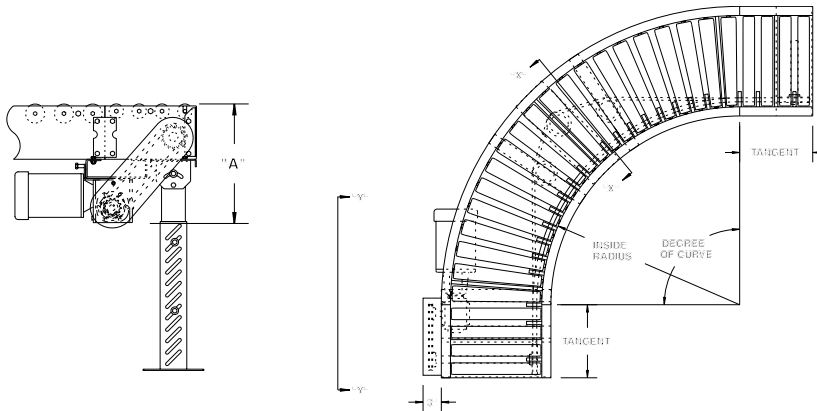

DETERMINING DRIVE LOCATION

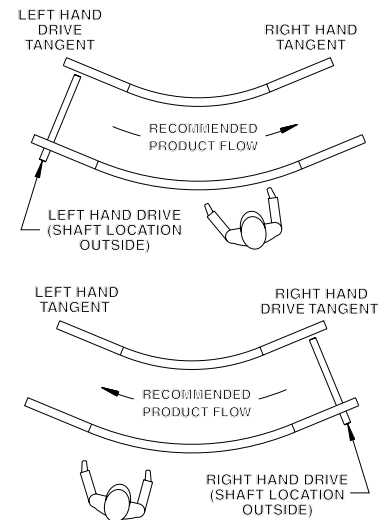

SPECIFICATIONS

TREAD ROLLERS: 2-1/2" dia. to 1-11/16" dia. x 14 ga. steel tapered rollers, model 254T; 1.9" dia. x 16 ga. steel straight tangent rollers, model 196S.

PRESSURE SHEAVES: Provides drive belt pressure to upper tread rollers.

BELT: "B" section V-belt.

TAKE-UP: Screw type adjustable sheaves provided to maintain belt tension.

TANGENTS: 1'-0" both ends on 90°; 1'-6" both ends on 45°; 1'-0" both ends on 180°. Tangent roller centers provided on 3" RC.

SPEED: 60 FPM, constant.

BED: 7" x 1-1/2" x 12 ga. formed steel channel frame.

BEARINGS: End shafts are supported by precision, heavy duty, lubricated, ball bearing units with cast iron housings.

ROLLER CHAIN: Drive shaft is driven by No. 50 chain.

DRIVE LOCATION: Drive located on outside of curve. Specify left hand tangent length, right hand tangent length and drive location ("left hand drive" or "right hand drive"). NOTE: Drive hand determined with reference point located at outside of curve. For models slave driven (less drive), specify drive shaft location.

CAPACITY: 500 lb. total distributed live load.

MOTOR DRIVE: 1/3 HP, 230/460/3, 60 cycle, ODP right angle gear motor, located at infeed end of curve below bed on 45° and 90° curves; 3/4 HP supplied on all 180° curves.

SPECIAL WIDTHS: Consult factory for pricing of ALL widths not shown.

ELECTRICAL CONTROLS: Optional.

HP@60 FPM	"A" MAX
1/3, 1/2	16-5/8"
3/4	17"
1	17-1/4"
1-1/2	18-1/8"
2	19"

NOTE: This unit is not recommended for accumulating loads.



SPECIFICATION TABLE

■ 24 hour shipment

MODEL			196LRC - 180°			196-LRC - 90°			196LRC - 45°		
BF	OAW	INSIDE RADIUS	TAPERED ROLLERS	STRAIGHT ROLLERS	WT.	TAPERED ROLLERS	STRAIGHT ROLLERS	WT.	TAPERED ROLLERS	STRAIGHT ROLLERS	WT.
13"	16"	2'-8-1/2'	40	8	298	20	8	207	10	12	161
15"	18"	2'-8-1/2'	40	8	341	20	8	231	10	12	176
17"	20"	2'-8-1/2'	40	8	383	20	8	255	10	12	190
19"	22"	2'-8-1/2'	40	8	426	20	8	279	10	12	205
21"	24"	2'-8-1/2'	40	8	468	20	8	303	10	12	220
23"	26"	2'-8-1/2'	40	8	511	20	8	327	10	12	234
25"	28"	2'-8-1/2'	40	8	553	20	8	351	10	12	249
27"	30"	2'-8-1/2'	40	8	596	20	8	374	10	12	264
31"	34"	4'-0"	56	8	681	28	8	422	14	12	293
33"	36"	4'-0"	56	8	723	28	8	446	14	12	308
37"	40"	4'-0"	56	8	808	28	8	494	14	12	337
39"	42"	4'-0"	56	8	851	28	8	518	14	12	352

OPTIONAL EQUIPMENT

SIDE MOUNTED END DRIVE: Provides minimum overall conveyor height of 10".

DRIVE: Located on inside radius of curve.

SPEED: Constant speed 10-120 FPM; DC variable speed; AC inverter variable speed. Other constant or variable speeds available.

FLOOR SUPPORTS: See Conveyor Accessories for various elevation and types.

CEILING HANGERS: 5/8" dia. threaded rod with hardware to attach rods to conveyor. Provides 6' clearance between ceiling and TOR (furnished in place of floor supports). See Conveyor Accessories.

TANGENT LENGTHS: 1'-6", 2'-0", 2'-6", 3'-0", 3'-6", 4'-0", 4'-6" and 5'-0" tangent lengths available on 45° and 90°. Total combined length of tangents not to exceed 6'-0".

GUARD RAILS: 1-3/4" x 1" formed channel (model GC), adjusts horizontally to 8" wider than roller and vertically to 6" above roller; formed steel fixed (model FSG in 2", 4", 6", 8", 12" and 18" heights; 1-1/2" angle (model GA1-1/2). See Conveyor Accessories.

MOTORS: Available through 3 HP in TEFC, explosion proof, dirty duty, brake motor, 115/230/1, 575/3, etc.

ELECTRICAL CONTROLS: Magnetic starter (one direction or reversible); One direction manual starter; Momentary start/stop push button station; Forward/reversing/stop push button station.

OPTIONAL SIDE MOUNTED END DRIVE

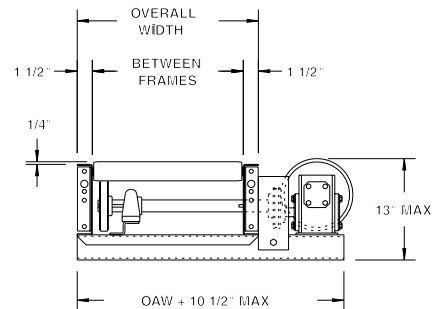

UNDERNEATH MOUNTED DRIVE



STRAIGHT TANGENT (located both ends of curve)